

Article number: 03446070

Description: Fluro Heavy Duty Spherical Plain Bearing GE 70 GW-2RS
Hole Ø70

Note: 70

Measures

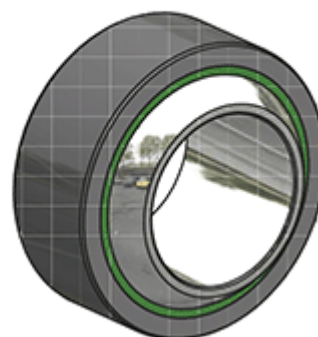
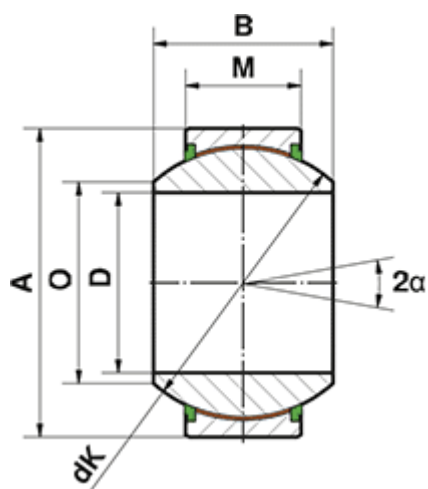

	= -	Dynamic load C (kN) = 1125
	= -	M = 45
	= -	O = 78.2
A	= 120	Static load C0 (kN) = 1875
a (degrees)	= 16	Weight (g) = 3000
B	= 70	
D	= 70	
dK	= 105	